



Orion

TWO SECTION EXAMINATION TABLE

The Orion two section examination table is designed to fulfill the basic requirements of patient assessment and examination, and is well suited to general practice, physiotherapy and sports injury treatment.

The Orion power-lift base has the capacity of lifting patients through a height range from seat height of 47 cm, to a maximum treatment height of 94 cm. This allows easy access for elderly and incapacitated patients while also achieving an ergonomic working height for the practitioner.

An integrated gas assisted backrest may be adjusted through a wide range of angles very easily with just one hand, leaving the other hand free for other tasks. A foot operated retractable wheel system allows the Orion table to be easily moved when required. In use the table sits securely on four solid supports that can be adjusted for an uneven floor.



*TGA registered 

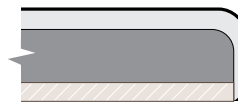

Supportive twin layer cushioning

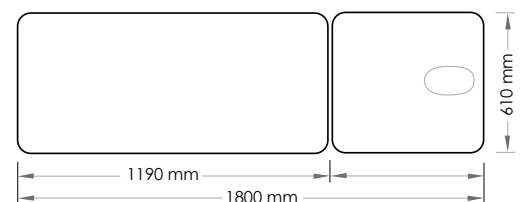
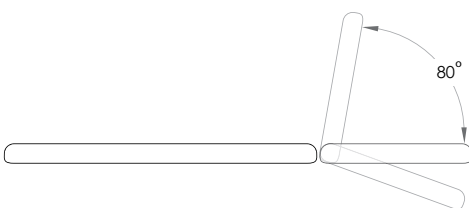

features

- Electric power height adjustment system is driven by a commercial grade linear actuator made in Germany ensuring fast, reliable and vibration free performance.
- Adjustable section features quality German gas struts that make adjusting the backrest easy and accurate, and provide extra security, support and rigidity.
- 8 pivot lifting arm mechanism, super strong with self lubricating nylon bushes to ensure smooth and quiet operation.
- Upholstery construction features high quality cfc free foam rubbers.
- High quality protective coated vinyl with oil resistant properties; durable, with a soft and comfortable feel.
- Foot operated retractable wheel system for ease of moving.
- Retractable castors with a chrome housing, steel bearings and a rubber wheel tread.
- Durable powder coated rust resistant frame.
- Built to last with very low maintenance.

specifications

Maneuverability

360° rotation, retractable nylon castors with a chrome housing, steel bearings, and rubber wheel tread.

Covering

PVC tested to AS 1441.11, AS 1530.3, AS 4088.1

Cushioning

CFC free, polyurethane foam

Frame

Powder coated, rust resistant steel frame

Maximum working height

940mm (with standard cushioning)

Minimum Height

470mm (with standard cushioning)

Maximum working load

175kg

Table Length

1800mm

Shipping dimensions

1900mm x 800mm x 800mm

Shipping weight

100kg

Warranty

Australia 3 years.

Free Call 1 800 813 000

www.athlegen.com



Official Supplier



ATHLEGEN[®]

Proudly Australian Made

Treatment 930

THREE SECTION

The Athlegen Treatment 930 is suitable for a wide range of modalities, including massage, acupuncture, osteopathy, beauty treatments, examinations and podiatry.

The Three Section configuration features a shorter seat section, perfect for positioning clients in a reclining or seated position, making it ideal for pedicures and podiatry treatments. The adjustable head section can include a face recess and can be slightly lowered enabling the prone patient to fully relax the neck muscles, giving optimum comfort during supine position treatments.

Optional face cradle extension with prone position armrest can also be fitted. Combine this with quiet height adjustment and you have discovered just a few reasons why this is the perfect table for your practice.

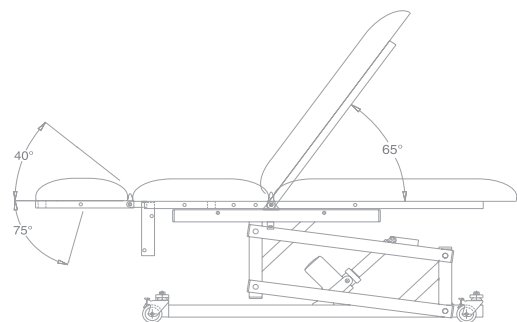
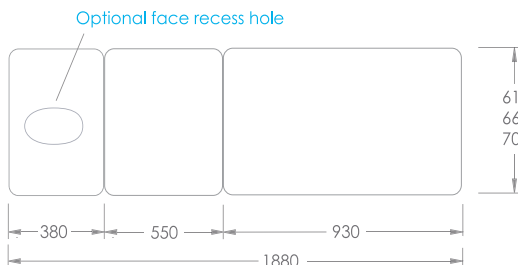

features

- Electric power height adjustment system is driven by a commercial grade linear actuator made in Germany ensuring fast, reliable and vibration free performance.
- Adjustable sections feature twin stainless steel control arms which provide extra security, support and rigidity.
- 8 pivot lifting arm mechanism, super strong, with self lubricating nylon bushings to ensure smooth and quiet operation.
- Upholstery construction features high quality Australian made cfc free foam rubbers.
- High quality protective coated vinyl with oil resistant properties; durable with a soft and comfortable feel.
- Choice of table top widths and cushioning constructions so you can customise the treatment area to best suit your needs.
- Heavy duty, industrial quality lockable castors with a chrome housing, steel bearings and a rubber wheel tread.
- Durable powder coated rust resistant frame.
- Heavy duty stainless steel footswitch
- Built to last with very low maintenance.

specifications

Maneuverability

360° rotation, heavy duty industrial quality lockable castors.

Covering

PVC tested to AS 1441.11, AS 1530.3, AS 4088.1

Cushioning

CFC free, polyurethane foam

Frame

Powder coated, rust resistant steel frame

Maximum working height

970mm (with Standard cushioning)

Minimum working height

480mm (with Standard cushioning)

Maximum working load

175kg

Power requirements

240 VAC @ 3.4 AMPS

Table Length

1880mm

Shipping dimensions

1900mm x 800mm x 800mm

Shipping weight

125kg

Warranty

Australia 5 years structural and 3 years motor. Extended warranty available. Other countries upon request.

Free Call 1 800 813 000

www.athlegen.com



Official Supplier



ATHLEGEN[®]

Proudly Australian Made



Treatment 680

THREE SECTION

The Athlegen Treatment 680 is suitable for a wide range of modalities, including massage, osteopathy, beauty treatments and examinations. The three section configuration features a shorter backrest (680mm) and a longer seat section than the Treatment 930 model. This configuration is better suited to modalities that need to treat clients in a seated position but require extra leg room. The adjustable head section includes a face recess and can be lowered enabling the prone patient to fully relax the neck muscles and achieve optimum comfort - ideal for massage treatments.

Optional face cradle extensions with armrests can also be fitted. The sturdy design helps to optimize your performance whilst achieving maximum comfort and support for your clients. Combine this with fast and quiet height adjustment and you have discovered just a few reasons why this could be the perfect table for your practice.

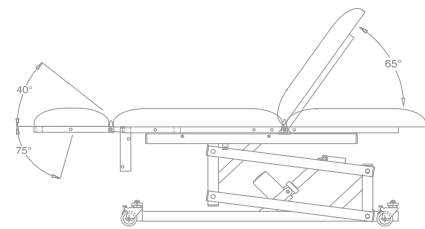
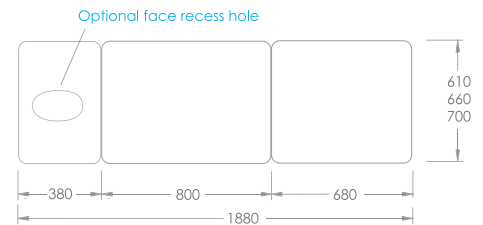

features

- Electric power height adjustment system is driven by a commercial grade linear actuator made in Germany ensuring fast, reliable and vibration free performance.
- Adjustable sections feature twin stainless steel control arms which provide extra security, support and rigidity.
- 8 pivot lifting arm mechanism, super strong with self lubricating nylon bushes to ensure smooth and quiet operation.
- Upholstery construction feature high quality Australian made cfc free foam rubbers.
- High quality protective coated vinyl with oil resistant properties; durable with a soft and comfortable feel.
- Choice of table top widths and cushioning constructions so you can customise the treatment area to best suit your needs.
- Heavy duty, industrial quality lockable castors with steel bearings and a rubber wheel tread.
- Durable powder coated rust resistant frame.
- Heavy duty stainless steel footswitch
- Built to last with very low maintenance.

specifications

Maneuverability

360° rotation, heavy duty industrial quality lockable castors.

Covering

PVC tested to AS 1441.11, AS 1530.3, AS 4088.1

Cushioning

CFC free, polyurethane foam

Frame

Powder coated, rust resistant steel frame

Maximum working height

970mm (with Standard cushioning)

Minimum working height

450mm (with Standard cushioning)

Maximum working load

175kg

Power requirements

240 VAC @ 3.4 AMPS

Table Length

1880mm

Shipping dimensions

1900mm x 800mm x 800mm

Shipping weight

125kg

Warranty

Australia 5 years structural and 3 years motor. Extended warranty available. Other countries upon request.

Free Call 1 800 813 000

www.athlegen.com



Official Supplier



ATHLEGEN[®]
Proudly Australian Made

Treatment AHS

TWO SECTION (Adjustable Head Section)



The Athlegen Treatment Table AHS is suitable for a wide range of modalities, including massage, acupuncture and osteopathy. The adjustable head section, which includes a face recess, can be lowered enabling the prone patient to fully relax the neck muscles thus achieving optimum comfort.

Optional face cradle extensions with armrests can also be fitted. The sturdy design helps to optimise your performance whilst achieving maximum comfort and support for your clients. Combine this with quiet and speedy height adjustment and you have discovered just a few reasons why this is the perfect table for your practice.

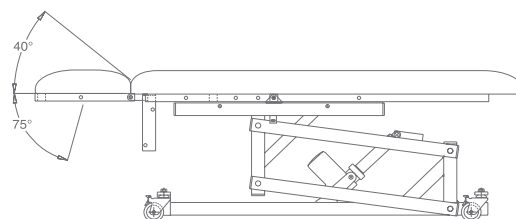
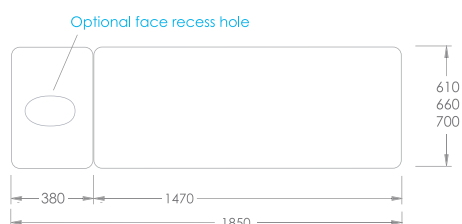

features

- Electric power height adjustment system is driven by a commercial grade linear actuator made in Germany ensuring fast, reliable and vibration free performance.
- Adjustable section feature twin stainless steel control arms which provide extra security, support and rigidity.
- 8 pivot lifting arm mechanism, super strong with self lubricating nylon bushes to ensure smooth and quiet operation.
- Upholstery construction features high quality Australian made cfc free foam rubbers.
- High quality protective coated vinyl with oil resistant properties; durable with a soft and comfortable feel.
- Choice of table top widths and cushioning constructions so you can customise the treatment area to best suit your needs.
- Heavy duty, industrial quality lockable castors with steel bearings and a rubber wheel tread.
- Durable powder coated rust resistant frame.
- Heavy duty stainless steel footswitch.
- Built to last with very low maintenance.

specifications

Maneuverability

360° rotation, heavy duty industrial quality lockable castors.

Covering

PVC tested to AS 1441.11, AS 1530.3, AS 4088.1

Cushioning

CFC free, polyurethane foam

Frame

Powder coated, rust resistant steel frame

Maximum working height

970mm (with Standard cushioning)

Minimum working height

480mm (with Standard cushioning)

Maximum working load

175kg

Power requirements

240 VAC @ 3.4 AMPS

Table Length

1850mm

Shipping dimensions

1900mm x 800mm x 800mm

Shipping weight

125kg

Warranty

Australia 5 years structural and 3 years motor. Extended warranty available. Other countries upon request.

Free Call 1 800 813 000 www.athlegen.com



Official Supplier



ATHLEGEN[®]
Proudly Australian Made

Treatment

SINGLE SECTION

The Athlegen Treatment Single Section is suitable for a wide range of modalities, including massage, acupuncture and osteopathy.

Optional face cradle extensions with armrests can also be fitted. The sturdy design helps to optimize your performance whilst achieving maximum comfort and support for your clients. Combine this with quiet and speedy height adjustment and you have discovered just a few reasons why this is the perfect table for your practice.

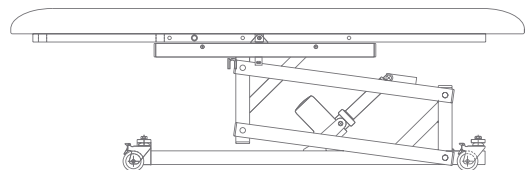

features

- Electric power height adjustment system is driven by a commercial grade linear actuator made in Germany ensuring fast, reliable and vibration free performance.
- Optional face recess and face cradle bracket allow this table to be customised to give greater client comfort during extended prone treatments.
- 8 pivot lifting arm mechanism, super strong with self lubricating nylon bushes to ensure smooth and quiet operation.
- Upholstery construction features high quality Australian made cfc free foam rubbers.
- High quality protective coated vinyl with oil resistant properties; durable, with a soft and comfortable feel.
- Choice of table top widths and cushioning constructions so you can customise the treatment area to best suit your requirements.
- Heavy duty, industrial quality lockable castors with steel bearings and a rubber wheel tread.
- Durable powder coated rust resistant frame.
- Heavy duty stainless steel footswitch
- Built to last with very low maintenance.

specifications

<p>Maneuverability 360° rotation, heavy duty industrial quality lockable castors.</p>	<p>Power requirements 240 VAC @ 3.4 AMPS</p>
<p>Covering PVC tested to AS 1441.11, AS 1530.3, AS 4088.1</p>	<p>Table Length 1840mm</p>
<p>Cushioning CFC free, polyurethane foam</p>	<p>Shipping dimensions 1900mm x 800mm x 800mm</p>
<p>Frame Powder coated, rust resistant steel frame</p>	<p>Shipping weight 125kg</p>
<p>Maximum working height 970mm (with Standard cushioning)</p>	<p>Warranty Australia 5 years structural and 3 years motor. Extended warranty available. Other countries upon request.</p>
<p>Minimum working height 480mm (with Standard cushioning)</p>	
<p>Maximum working load 175kg</p>	

Free Call 1 800 813 000 www.athlegen.com



Official Supplier

ATHLEGEN
Proudly Australian Made